

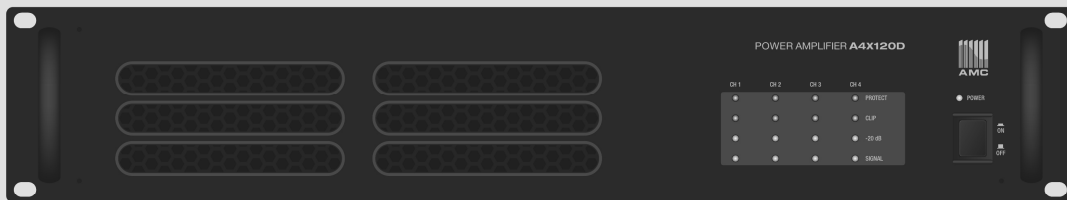

A4X120D

Power amplifier



User manual

IMPORTANT SAFETY INSTRUCTIONS

CAUTION!

THIS PRODUCT UTILIZES A LASER. USE OF CONTROLS OR ADJUSTMENTS OR PERFORMANCE OF PROCEDURES OTHER THAN THOSE SPECIFIED HEREIN MAY RESULT IN HAZARDOUS RADIATION EXPOSURE. DO NOT OPEN COVERS AND DO NOT REPAIR YOURSELF. REFER SERVICING TO QUALIFIED PERSONNEL.

WARNING:

TO REDUCE THE RISK OF FIRE, ELECTRIC SHOCK OR PRODUCT DAMAGE, DO NOT EXPOSE THIS APPARATUS TO RAIN, MOISTURE, DRIPPING OR SPLASHING AND THAT NO OBJECTS FILLED WITH LIQUIDS, SUCH AS VASES, SHALL BE PLACED ON THE APPARATUS.



When using this electronic device, basic precautions should always be taken, including the following:

1. Read all instructions before using the product.
2. Do not use this product near water (e.g., near a bathtub, washbowl, kitchen sink, in a wet basement or near a swimming pool etc).
3. Use this device when you are sure that amplifier has a stable base and it is fixed securely.
4. This product, in combination with loudspeakers may be capable of producing sound levels that could cause permanent hearing loss. Do not operate for a long period of time at a high volume level or at a level that is uncomfortable. If you experience any hearing loss or ringing in the ears, you should consult with otorhinolaryngologists. The product should be positioned so that proper ventilation is maintained.
5. The product should be located away from heat sources such as radiators, heat vents, or other devices (including amplifiers) that produce heat.
6. The product should be connected to a power supply that is described in the operating instructions or are marked on the product. Replace the fuse only with one of the specified type, size and correct rating.
7. The power supply cord should be undamaged and never share an outlet or extension cord with other devices so that the outlet or extension cord's power rating is exceeded. Never leave device plugged into the outlet when it is not being used for a long period of time.
8. Care should be taken so that objects do not fall into, and liquids would not be spilled through, the enclosure's openings.
9. The product should be serviced by qualified service personnel if:
 - The power supply cord or the plug has been damaged.
 - Objects have fallen into or liquid has been spilled on the product.
 - The product has been exposed to rain.
 - The product has been dropped or the enclosure damaged.
10. There are some areas with high voltage inside, to reduce the risk of electric shock do not remove cover of the amplifier. The cover should be removed by the qualified personnel only.

No user serviceable parts inside.

CONTENTS:

| | |
|--------------------------------|----|
| <u>Before you start</u> | |
| Introductions | 4 |
| Features | 4 |
| <u>Operation</u> | |
| Front panel | 5 |
| Rear panel | 5 |
| Function description | 6 |
| Output terminal | 7 |
| <u>Controls and connectors</u> | |
| Connectors | 8 |
| Cable wiring examples | 8 |
| Block diagram | 11 |
| <u>Specifications</u> | |
| General specifications | 12 |

Introduction

These A4X120D four channel D - class power player amplifiers are designed for public address systems such as: paging, announcements and background music broadcasting in industrial plants, offices, schools, shopping centers, night clubs, dining rooms, conference hall, auditoriums and recreations areas.

Features

- Four free-standing D - class amplifiers with 120W rated power.
- Switching power supply.
- Balanced XLR input and link connectors.
- Phoenix output connectors
- HPF filter for each input.
- Independent input level controls for each channel.
- Signal, protect and clip indicators.
- Multi-stage protection from, over-heating, over-current, short circuit, low output impedance and DC voltage.

5 Operation

Front Panel

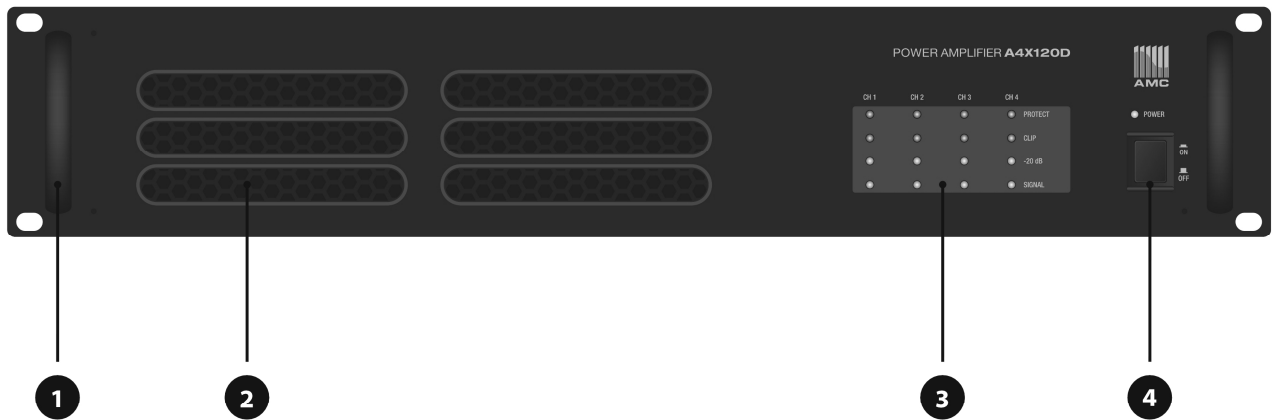

1. Handle
2. Cooling vent

3. Status indicators
4. Power switch

Rear Panel

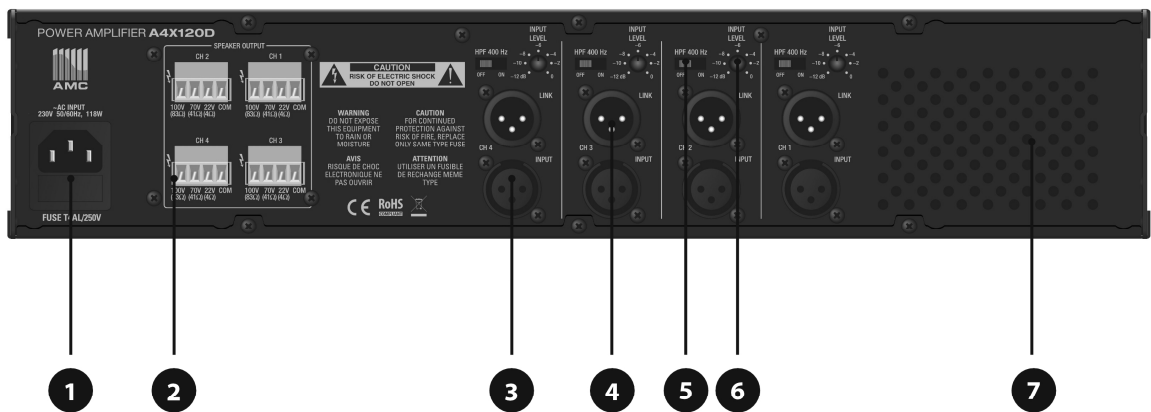

1. Power connector and AC fuse (T4AL 250V)
2. Phoenix output
3. Balanced XLR input
4. Balanced XLR link output

5. HPF 400Hz filter switch
6. Input level control
7. Cooling vent

Functions description

HANDLES

For easy transport while carrying, or while rack mounting, the amplifier features two handles located conveniently on the left and right sides of the front panel.

COOLING VENTS

Cool air is pulled in through the front panel fan filters and eliminated through the rear panel vents.

CLIP LED

Lights whenever the channel is outputting signal at full strength and signal is distorted. Reduce signal level to ensure undistorted output signal.

PROTECTION LED

This LED lights up for approximately one second after the A4X120D is powered on and then turns off if the amplifier is not damaged. This LED also lights when overheating or other severe problems occur. It is normal for the protection LED to fade slowly when the amplifier is powered off.

SIGNAL LED

LED in the front panel indicates audio signal of the corresponding channel.

POWER SWITCH

Use this switch to power on or off the amplifier. The LED in the front panel lights up if the amplifier is powered on.

POWER CONNECTOR

Power connector is designed for main powers connecting to amplifier. This connector is combined with fuse holder and 4A, 250V fuse.

PHOENIX OUTPUT

Use these to connect each channel with A4X120D to 4 Ω or 8 Ω loudspeakers, or to one of the 70 and 100 volt outputs if you are using a constant voltage system.

BALANCED XLR INPUT

Connect audio signal to these electronically balanced connectors. Please note that the A4X120D needs at least 0 dBu to achieve maximum power.

LINK

Connects outgoing signals from these XLR connectors. Input and link connectors are connected with each other directly.

HIGH PASS FILTER

HPF filter reduce low frequency is in the audio signal.

LEVEL CONTROL

These controls allow you to precisely adjust the input level of the signal arriving at the rear-panel input connectors. At their fully counterclockwise position, the signal is attenuated by -12 dB. At their fully clockwise position, the signal is no attenuated. When 0dBu of signal arrives at the input and the input level controls are set to their fully clockwise position (0dBu), the Amplifier delivers full power.

7 Operation

Output terminal

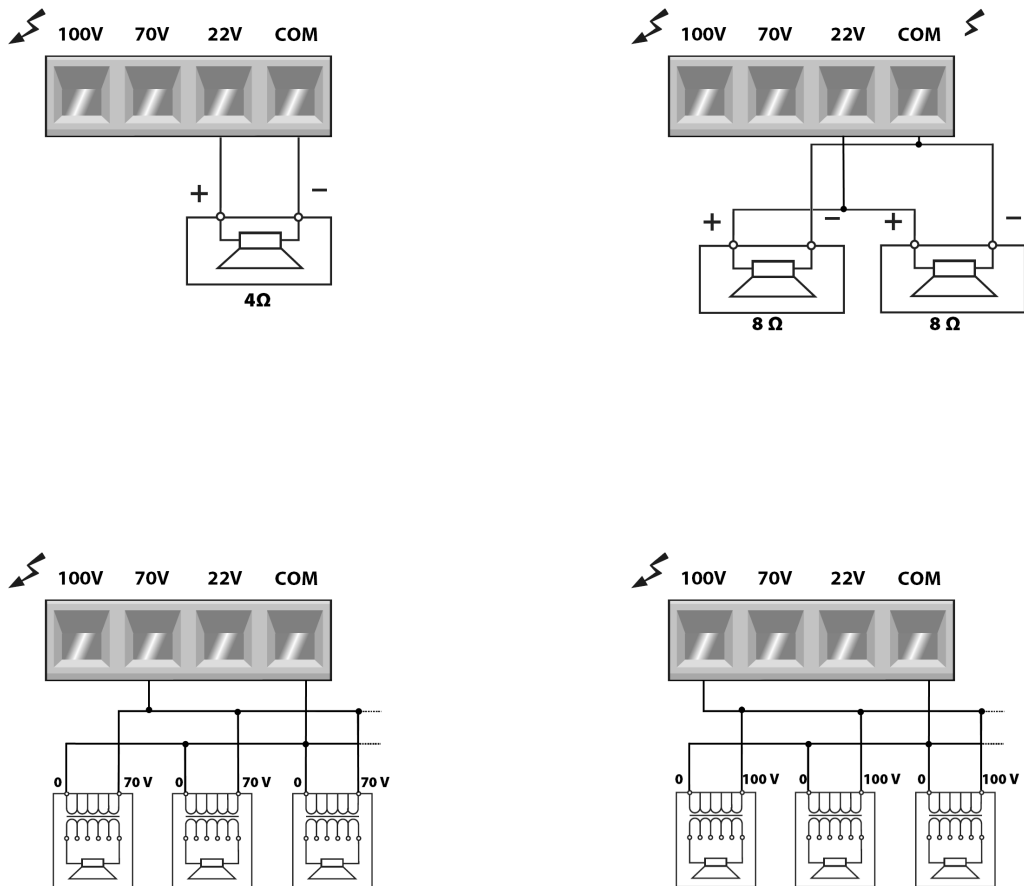

Each of the amplifier channels can run only one output configuration at the same time. Operating amplifiers using 4 ohm and 70 or 100 volt concurrently may cause damage to the amplifier or connected speakers.

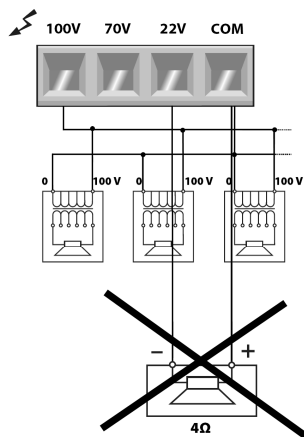

Connectors

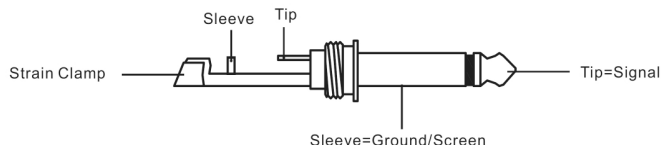

TS connector

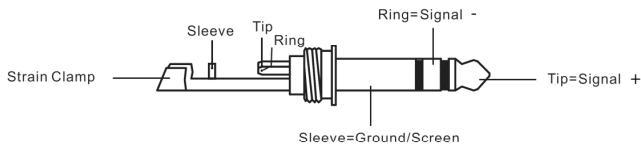

TRS connector

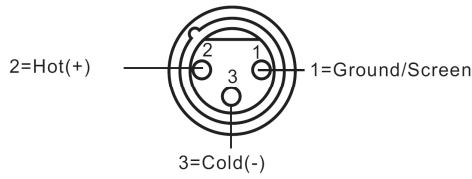

XLR male connector

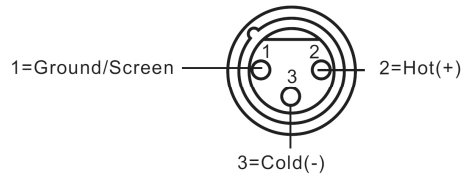

XLR female connector

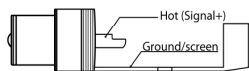

RCA connector

Cable wiring examples



Cable to balanced input from balanced output. TRS connectors.



Cable to unbalanced input from balanced output. TRS and TS connectors.



Cable to balanced input from unbalanced output. TS and TRS connectors.



Cable to unbalanced input from unbalanced output. TS connectors.

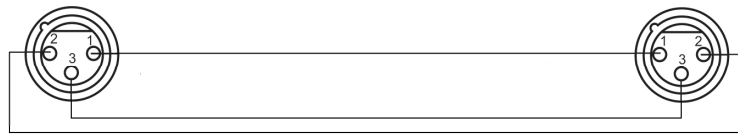

Cable to balanced input from balanced output. XLR connectors.

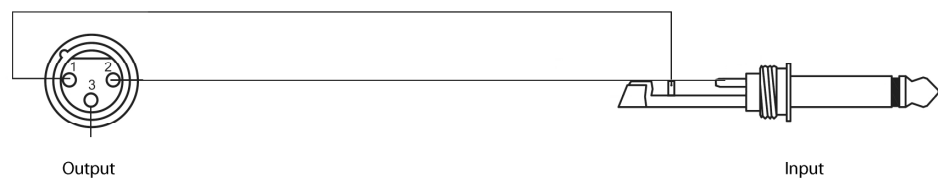

Cable to unbalanced input from balanced output. XLR and TS connectors.

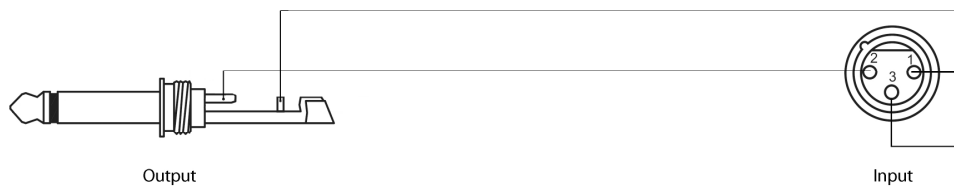

Cable to balanced input from unbalanced output. TS and XLR connectors.

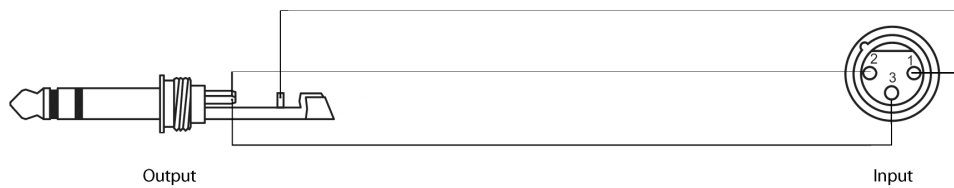

Cable to balanced input from balanced output. TRS and XLR connectors.



RCA cable.

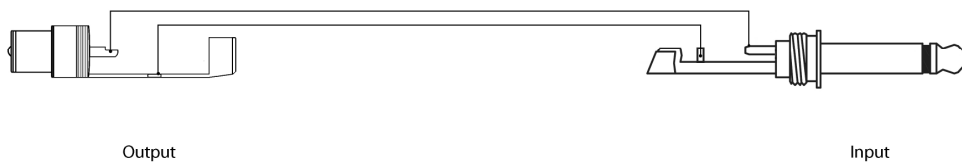

Cable to unbalanced input from RCA output. RCA and TS connectors.

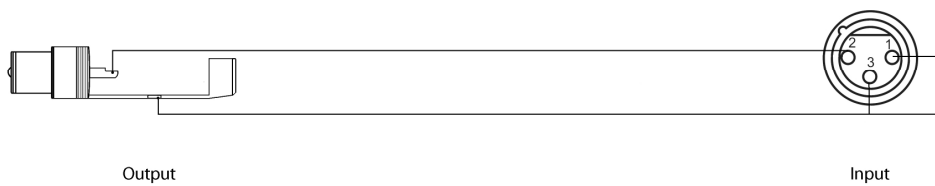

Cable to balanced input from RCA output. RCA and XLR connectors.

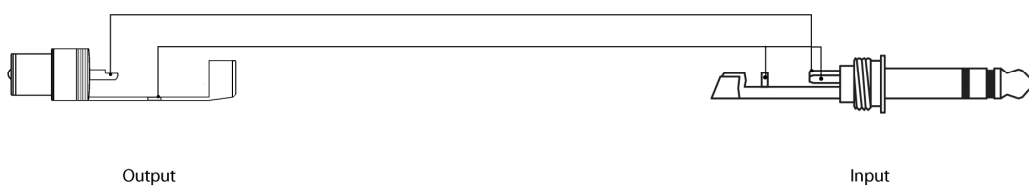

Cable to balanced input from RCA output. RCA and TRS connectors.



Cable to RCA input from balanced output. RCA and XLR connectors.

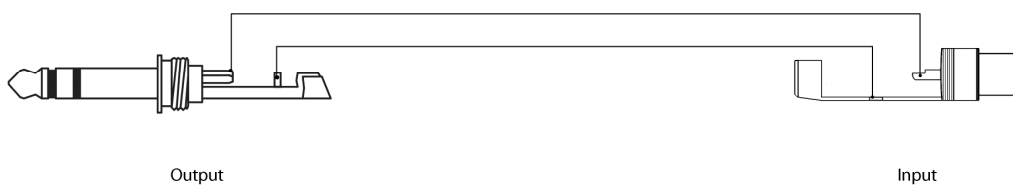

Cable to RCA input from balanced output. RCA and TRS connectors.

Block diagram

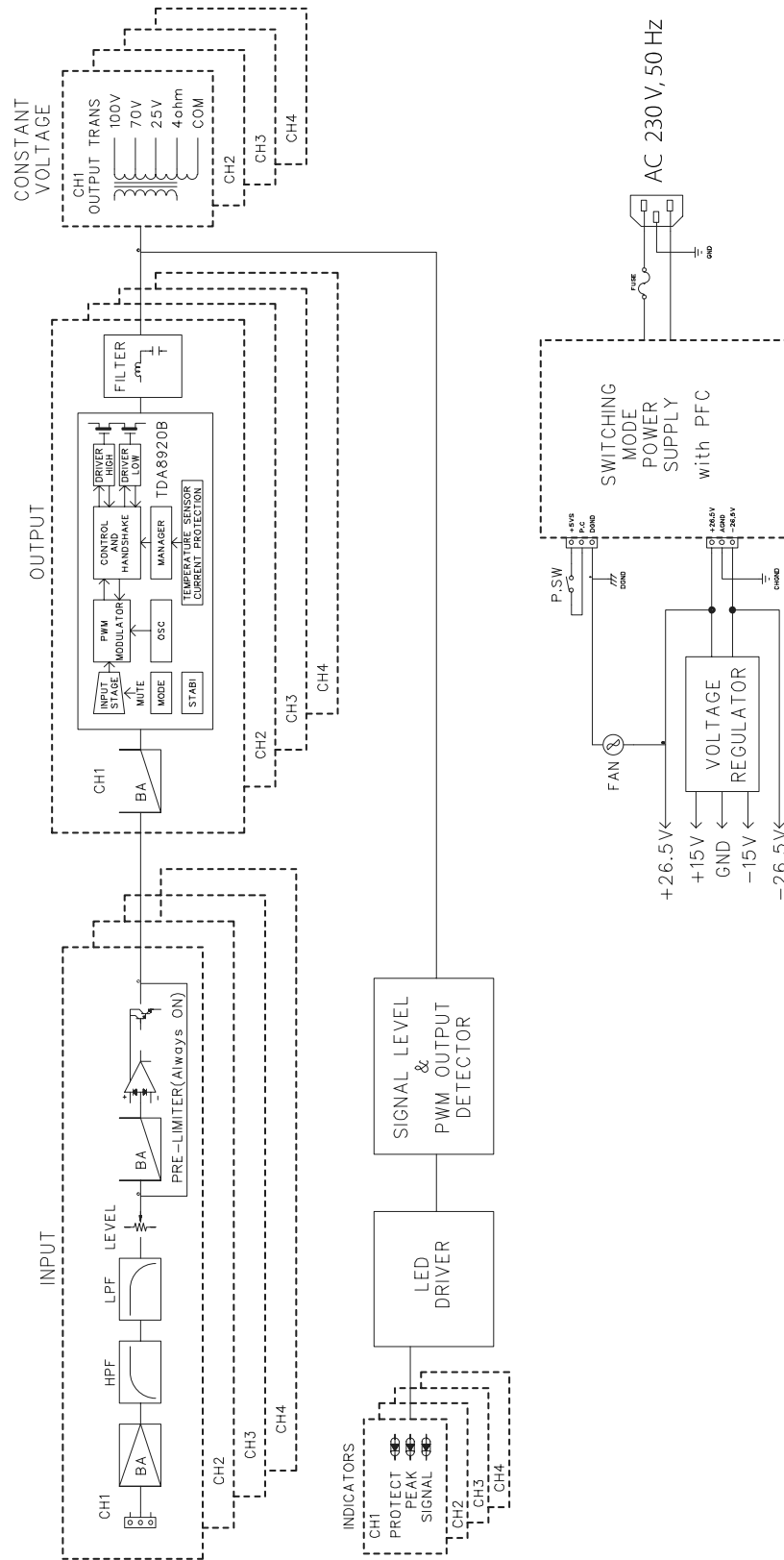

General specifications

| | |
|---------------------------------------|---|
| Power supply | AC 230 V, 50 Hz |
| Output power | 4 x 120 W |
| AC power consumption (Standby) | 33 W |
| AC power consumption | 550 W @ RATED POWER |
| Total harmonic distortions | < 5 % |
| Input sensitivity | 0 dBu |
| Max input level | + 26 dBu |
| S/N ratio | 90dB |
| Frequency response | 50 Hz – 18 kHz +/- 3 dB |
| Protection | Short circuit, thermal, current limit, DC offset, current inrush, RF protection, Turn on/Turn off muting. |
| Cooling | Fan forced air. |
| Indicators | Power on, protection, signal, clip. |
| Controls | Power switch, input level, HPF filter. |
| Output | 100 V, 70 V, 22 V |
| Dimensions | 88 mm (H) x 482 mm (W) x 433 mm (D) |
| Weight | 17,8 kg |